

all measures in cm

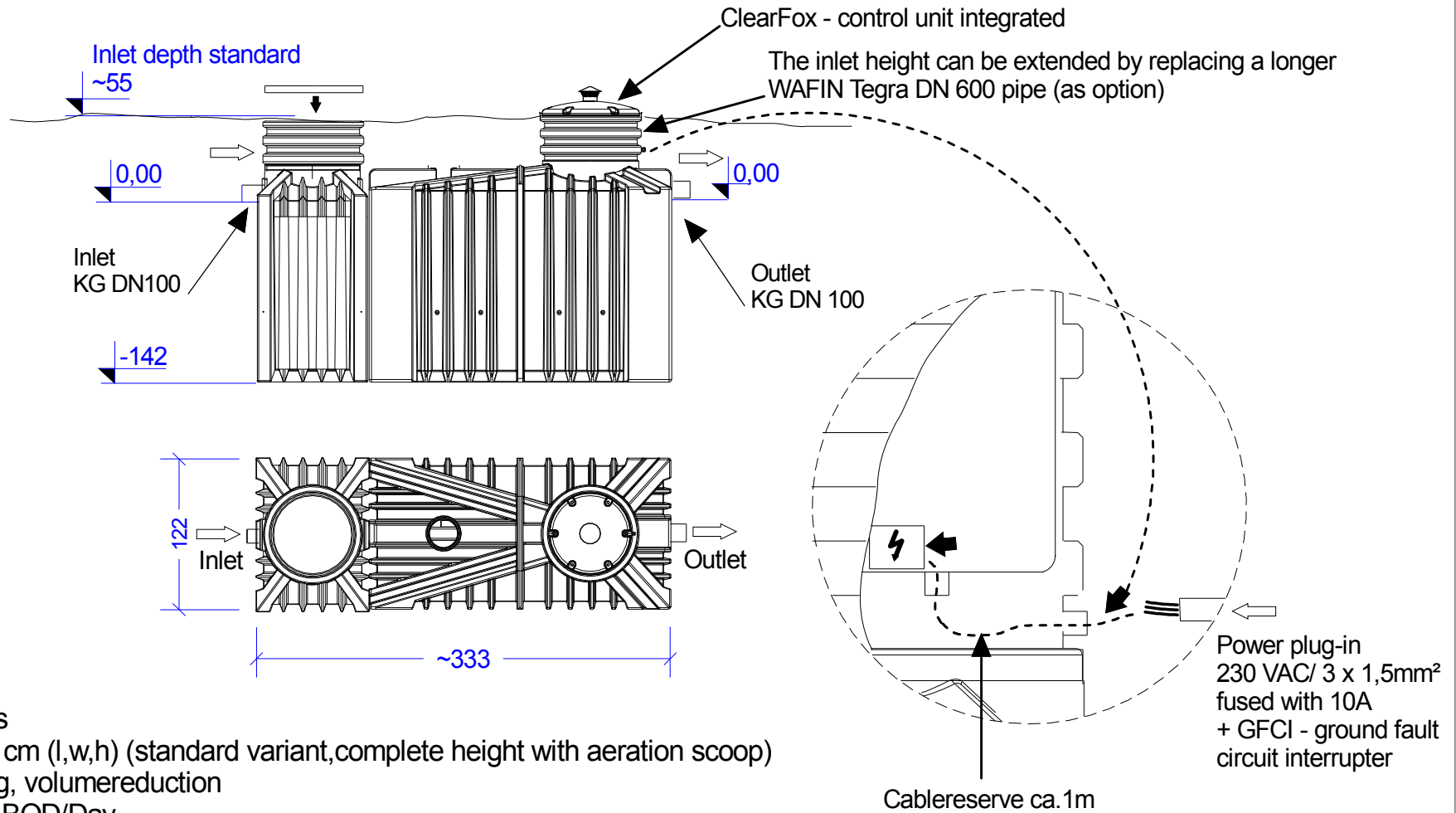

Specification:

Population range: 8 persons
 Measures: 333 x 122 x 220 cm (l,w,h) (standard variant, complete height with aeration scoop)
 Sludge treatment: stabilizing, volumereduction
 Max. organic loading: 480g BOD/Day
 Max. average daily flow: 1200 L
 Max. blower power consumption: 0,12 kw
 Weight (total/plug&play): ~270 kg
 Total capacity: 4750 L

ClearFox- QuickONE +
 small wwtp 8 p.e.
 Single chamber SBR system
 according EN 12566-3